

## CMS Tecnocut Idea 3040 CNC Waterjet Cutting System

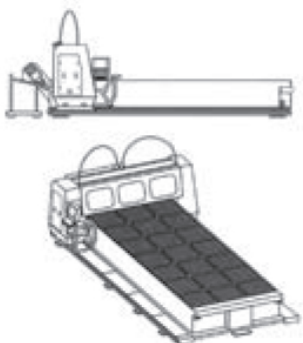

The CMS Tecnocut Idea is a revolutionary concept in waterjet cutting allowing a modular heavy duty format which can be increased with users requirements.

Combining over 20 years of CMS technology, CMS have created a machine in the Idea that combines an extremely heavy duty gantry structure that can have multiple heads per gantry and a modular independent rail/tank assembly that allows multiple gantries on the same machine. Standard gantry width is 2 or 3 metres and bed lengths start at 4 metres and can be extended to 12 metres and beyond.



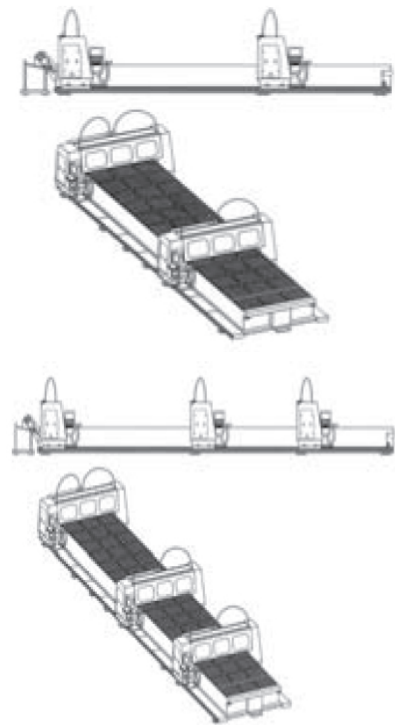

## Features

- 3 Axis Gantry frame with Stainless Steel tank
- Automated Conveyor Dredge system for abrasive removal
- Ground Rack & Pinions with Brushless Servos motor drives
- Automatic Axis lubrication
- Control Console mounted on the gantry
- Electronic management of Abrasive consumption with feedback of cut parameters
- Tecnocut 3 Axis Cutting head with automatic height adjustment, Abrasive or water capability, automatic dispenser and mixing chamber
- Photoelectric Safety Barrier system
- Powerful TecnoCam Machine Control and Nesting software
- Pressurised Abrasive feeding system with 330KG capacity
- Remote control

An advanced innovation that the Idea offers is its unique automated Dredge system. This utilises a heavy duty conveyor that runs in a valley in the centre of the tank and passes the used abrasive up and out of the tank into a waste container. The result is no manual abrasive removal which is often a labour intensive and dirty task that every waterjet operator generally has to undertake. This is a huge innovation and sets the Idea apart from other waterjet machines on the market.

Another key feature is the enclosed guarding around the gantry cutting area. This safety features massively reduces noise and debris resulting from the cutting process helping to ensure the profiling environment is as safe and clean as possible.

Standard with the CMS Waterjet Range is their powerful Tecnocam CAM and Nesting optimisation software with full training and installation provided on the system and software. Also standard on the Idea is an automated machine maintenance feature built into the CNC providing instant visibility of the consumable and abrasive use and maintenance recommendations.

See the options list for more details on further Waterjet Pump and customisation options on the Idea range.

## Technical Specification

MODEL	Idea 3040
Table Dimensions mm	3000 x 4000
Z Axis Height mm	200mm
B Axis (5 Axis)	+/- 60°
Overall Dimensions mm	7000 x 5500

## Options

- Additional Mobile Cutting Gantries
- Single 5 Axis Bevel Head
- 3 Axis Std head and 5 Axis IKC Bevel Head
- Two 5 Axis IKC Bevel Heads
- Various table slat arrangements to suit different materials

- 30HP Easypump
- 60HP Easypump
- 30HP Jetpower Air/Oil Pump
- 60HP Jetpower Air/Oil Pump
- 120HP Jetpower Air/Oil Pump
- Laser Location Pointer
- Anti Collision Feeler system
- 3 Axis Drilling Unit
- 2000KG Abrasive Feeding System